

作成日	2018/02/22	縮尺	A3 1:20		
作図	設計	検図	承認	Title	
				製品No,	No.34-a-プラン図
				製品名	

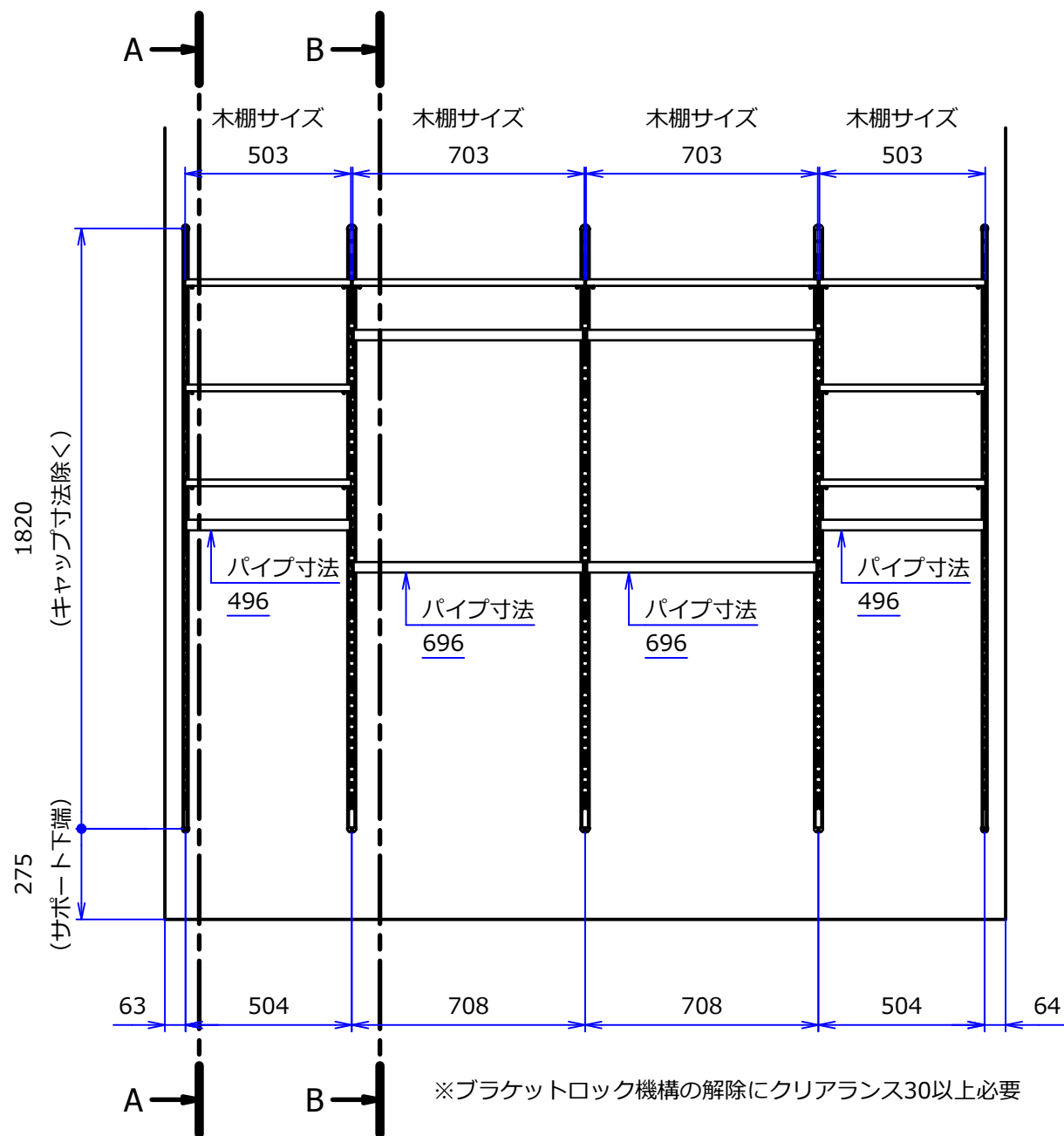

A-A (1 : 20)

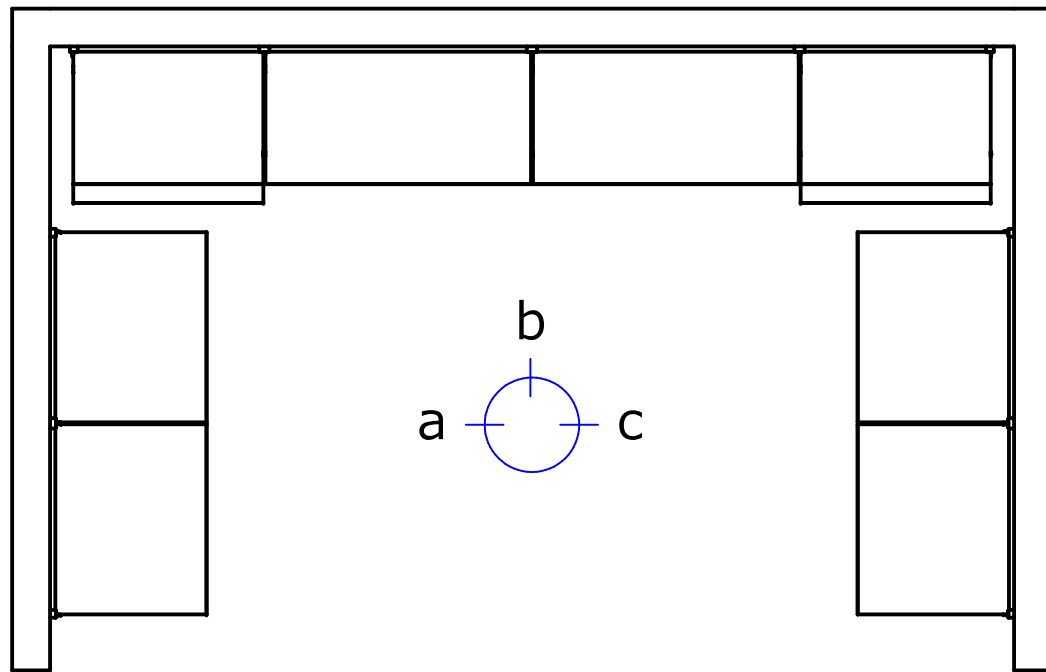
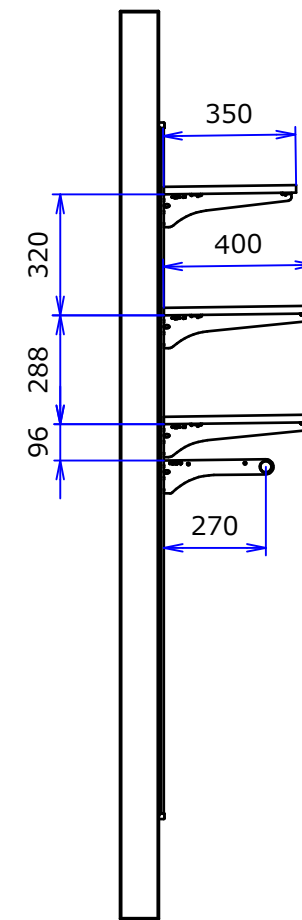

B-B (1 : 20)

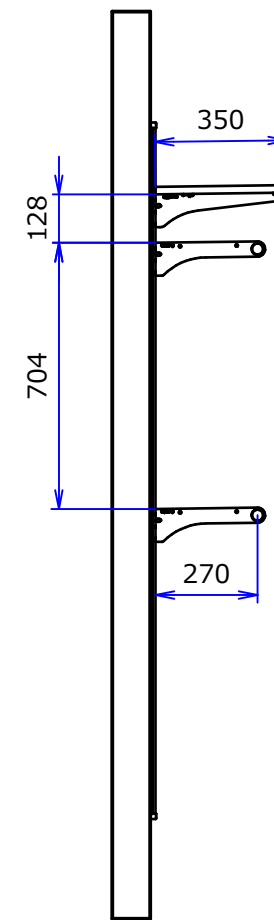

作成日	2018/02/22	縮尺	A3 1:20		
作図	設計	検図	承認	Title	
				製品No,	No.34-b-プラン図
				製品名	

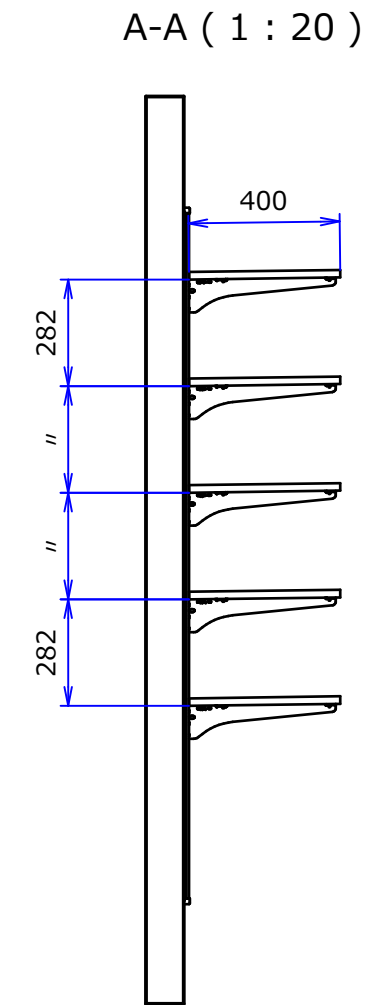
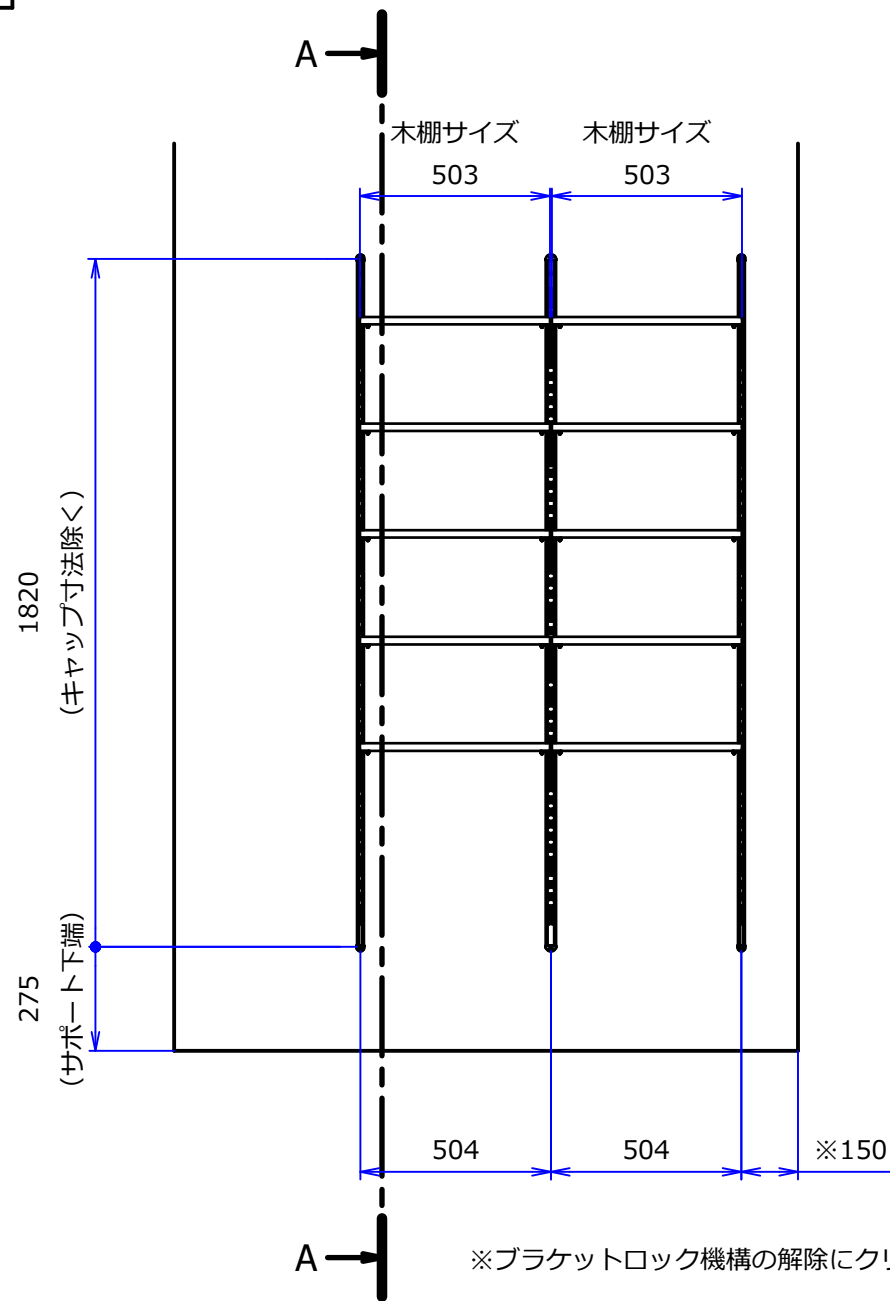
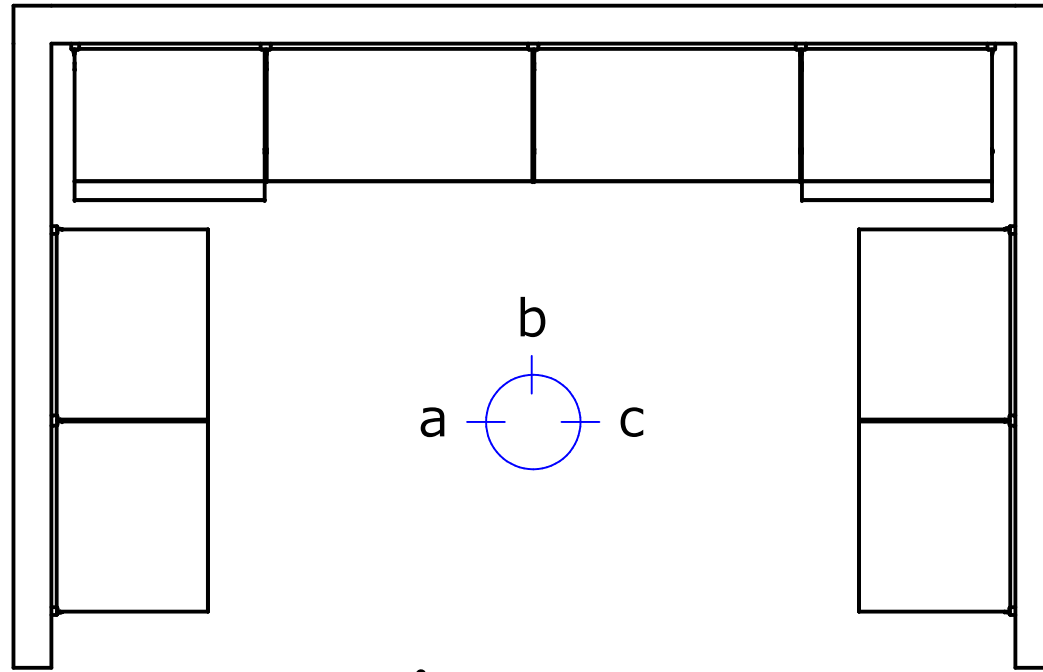

作成日	2018/02/22	縮尺	A3 1:20		
作図	設計	検図	承認	Title	
				製品No,	No.34-c-プラン図
				製品名	